

- 1
- 2
- 3
- 4
- 5
- 6
- 7
- 8
- 9
- 10
- 11
- 12
- 13
- 14
- 15

MATERIAL

High-resilience polypropylene based (PP) technopolymer, black colour, matte finish.

BOSS CAP

Acetal resin based (POM) technopolymer, light-grey colour, push-fit assembly.

STANDARD EXECUTIONS

Black-oxide steel boss, H7 reamed hole.

- **VDS.**: without handle.
 - **VDS+I**: with revolving handle I.621+x (see page 406) in technopolymer.
 - **VDS+IEL**: with revolving handle IEL+x-SOFT (see page 377) in technopolymer coated with "Soft touch" thermoplastic elastomer (TPE).
 - **VDS+IR**: with fold-away handle IR.620 (see page 414) in technopolymer.
 - **VDS+IRS**: with safety fold-away handle IRS.820 (see page 416) in technopolymer.
- AISI 304 stainless steel boss, H7 reamed hole.
- **VDS-SST**: without handle.
 - **VDS+I-SST**: with revolving handle I.621+x-SST (see page 406) in technopolymer.
 - **VDS+IR-SST**: with fold-away handle IR.620-SST (see page 414) in technopolymer.
 - **VDS+IRS-SST**: with safety fold-away handle IRS.820-SST (see page 416) in technopolymer.

ACCESSORIES ON REQUEST

- Axial retaining washer in black-oxide steel GN 184 (see page 677) or in AISI 303 stainless steel GN 184.5 (see page 677).
- VDS.125, VDS.150 and VDS.175 are available also with technopolymer boss cap in one of the Ergostyle colours (see ECB. table).

SPECIAL EXECUTIONS ON REQUEST

Bosses with hole and keyway in compliance with DIN 6885/1 tolerance P9 (see page A-16).

To order the handwheel with keyway add the index -K after the code and the description (i.e. 72661-R-K VDS.100 A-10-K).

Code	Description	Boss cap for
29582-*	ECB.D2-*	VDS.125
29583-*	ECB.D3-*	VDS.150
29584-*	ECB.D4-*	VDS.175

* Complete with colour index (C1, ..., C6).

C1	C2	C3	C4	C5	C6
RAL7021	RAL2004	RAL7035	RAL1021	RAL5024	RAL3000



ELESA Original design

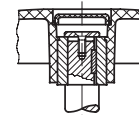

Assembly example with keyway and axial set screw

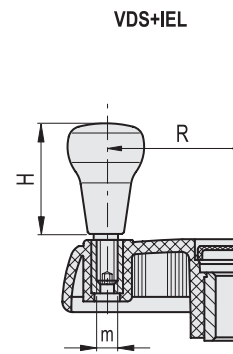
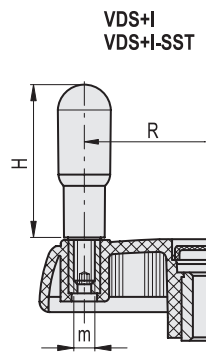
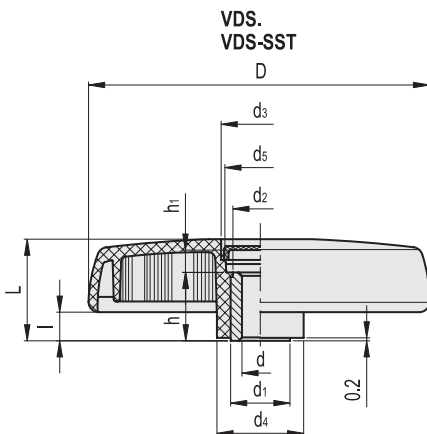

VDS.

Code	Description	D	dH7	L	d1	d2	d3	d4	d5	l	h	h1	C# [Nm]	L# [J]	
72641-R	VDS.80-A-8	83	8	29	18	16	21	26	19	9	17	8	34	6	84
72642-R	VDS.80-A-10	83	10	29	18	16	21	26	19	9	17	8	34	6	86
72660-R	VDS.100 A-8	102	8	34	22	20	27	30	25	10	22	9	60	13	145
72661-R	VDS.100 A-10	102	10	34	22	20	27	30	25	10	22	9	60	13	140
72662-R	VDS.100 A-12	102	12	34	22	20	27	30	25	10	22	9	60	13	135
72740-R	VDS.150 A-8	150	8	44	26	24	34	38	30	12	30	10	180	26	335
72741-R	VDS.150 A-14	150	14	44	26	24	34	38	30	12	30	10	180	26	315
72840-R	VDS.200 A-8	200	8	53	40	38	44	50	40	14	36	13	320	27	620
72841-R	VDS.200 A-20	200	20	53	40	38	44	50	40	14	36	13	320	27	590

VDS-SST

INOX STAINLESS STEEL

Code	Description	D	dH7	L	d1	d2	d3	d4	d5	l	h	h1	C# [Nm]	L# [J]	
72665-R	VDS.100-SST-10	102	10	34	22	20	27	30	25	10	22	9	60	13	141
72745-R	VDS.150-SST-14	150	14	44	26	24	34	38	30	12	30	10	180	26	318
72845-R	VDS.200-SST-20	200	20	53	40	38	44	50	40	14	36	13	320	27	596

VDS+I

Code	Description	D	dH7	L	d1	d2	d3	d4	d5	l	h	h1	H	m	R	C# [Nm]	L# [J]	
72651-R	VDS.80+I A-8	83	8	29	18	16	21	26	19	9	17	8	45	M6	30.5	34	6	106
72652-R	VDS.80+I A-10	83	10	29	18	16	21	26	19	9	17	8	45	M6	30.5	34	6	108
72670-R	VDS.100+I A-8	102	8	34	22	20	27	30	25	10	22	9	60	M6	39	60	13	180
72671-R	VDS.100+I A-10	102	10	34	22	20	27	30	25	10	22	9	60	M6	39	60	13	174
72672-R	VDS.100+I A-12	102	12	34	22	20	27	30	25	10	22	9	60	M6	39	60	13	168
72700-R	VDS.125+I A-8	125	8	39.5	26	24	31	35	28	11	27	11	60	M6	49	125	25	282
72701-R	VDS.125+I A-12	125	12	39.5	26	24	31	35	28	11	27	11	60	M6	49	125	25	270
72702-R	VDS.125+I A-14	125	14	39.5	26	24	31	35	28	11	27	11	60	M6	49	125	25	258
72750-R	VDS.150+I A-8	150	8	44	26	24	34	38	30	12	30	10	65	M8	56.5	180	26	399
72751-R	VDS.150+I A-14	150	14	44	26	24	34	38	30	12	30	10	65	M8	56.5	180	26	379
72752-R	VDS.150+I A-16	150	16	44	26	24	34	38	30	12	30	10	65	M8	56.5	180	26	359
72800-R	VDS.175+I A-8	176	8	49	35	33	39	44	35	13	28	16	80	M10	70	195	26	530
72801-R	VDS.175+I A-16	176	16	49	35	33	39	44	35	13	28	16	80	M10	70	195	26	500
72802-R	VDS.175+I A-20	176	20	49	35	33	39	44	35	13	28	16	80	M10	70	195	26	470
72850-R	VDS.200+I A-8	200	8	53	40	38	44	50	40	14	36	13	90	M10	81	320	27	714
72851-R	VDS.200+I A-20	200	20	53	40	38	44	50	40	14	36	13	90	M10	81	320	27	674
72852-R	VDS.200+I A-24	200	24	53	40	38	44	50	40	14	36	13	90	M10	81	320	27	634
72911-R	VDS.250+I A-20	250	20	60	40	38	50	57	48	17	36	19	90	M10	104	500	30	934
72961-R	VDS.300+I A-20	300	20	66	40	36.5	68.5	72	66	20	44	20	90	M10	124	500	30	1260

VDS+I-SST

INOX STAINLESS STEEL

Code	Description	D	dH7	L	d1	d2	d3	d4	d5	l	h	h1	H	m	R	C# [Nm]	L# [J]	
72675-R	VDS.100+I-SST-10	102	10	34	22	20	27	30	25	10	22	9	60	M6	39	60	13	175
72705-R	VDS.125+I-SST-12	125	12	42	26	24	31	35	28	11	27	11	60	M6	49	125	25	273
72755-R	VDS.150+I-SST-14	150	14	44	26	24	34	38	30	12	30	10	65	M8	56.5	180	26	383
72855-R	VDS.200+I-SST-20	200	20	53	40	38	44	50	40	14	36	13	90	M10	81	320	27	681

VDS+IEL

Code	Description	D	dH7	L	d1	d2	d3	d4	d5	l	h	h1	H	m	R	C# [Nm]	L# [J]	
72966-R	VDS.300+IEL A-20	300	20	66	40	36.5	68.5	72	66	20	44	20	65	M10	124	500	30	1270

For maximum torque (C) and impact strength (L) see Technical data on page A-3.

- 1
- 2
- 3
- 4
- 5
- 6
- 7
- 8
- 9
- 10
- 11
- 12
- 13
- 14
- 15
- RH

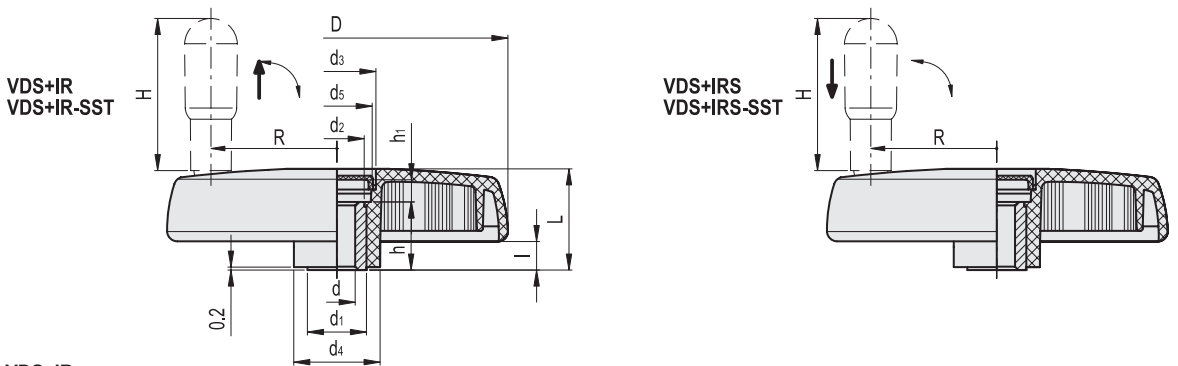

VDS+IR

Code	Description	D	dH7	L	d1	d2	d3	d4	d5	l	h	h1	H	R	C# [Nm]	L# [J]	
72656-R	VDS.80+IR A-8	83	8	38	18	16	16.5	25	13.5	18.5	17	3.5	45	28	34	6	133
72657-R	VDS.80+IR A-10	83	10	38	18	16	16.5	25	13.5	18.5	17	3.5	45	28	34	6	129
72680-R	VDS.100+IR A-8	102	8	34	22	20	27	30	25	10	22	9	45	39	60	14	177
72681-R	VDS.100+IR A-10	102	10	34	22	20	27	30	25	10	22	9	45	39	60	14	170
72682-R	VDS.100+IR A-12	102	12	34	22	20	27	30	25	10	22	9	45	39	60	14	163
72710-R	VDS.125+IR A-8	125	8	39.5	26	24	31	35	28	11	27	11	60	49	125	14	311
72711-R	VDS.125+IR A-12	125	12	39.5	26	24	31	35	28	11	27	11	60	49	125	14	307
72712-R	VDS.125+IR A-14	125	14	39.5	26	24	31	35	28	11	27	11	60	49	125	14	303
72760-R	VDS.150+IR A-8	150	8	44	26	24	34	38	30	12	30	10	65	56.5	180	15	450
72761-R	VDS.150+IR A-14	150	14	44	26	24	34	38	30	12	30	10	65	56.5	180	15	432
72762-R	VDS.150+IR A-16	150	16	44	26	24	34	38	30	12	30	10	65	56.5	180	15	415
72810-R	VDS.175+IR A-8	176	8	49	35	33	39	44	35	13	28	16	80	70	195	20	588
72811-R	VDS.175+IR A-16	176	16	49	35	33	39	44	35	13	28	16	80	70	195	20	577
72812-R	VDS.175+IR A-20	176	20	49	35	33	39	44	35	13	28	16	80	70	195	20	565
72860-R	VDS.200+IR A-8	200	8	53	40	38	44	50	40	14	36	13	90	81	320	27	750
72861-R	VDS.200+IR A-20	200	20	53	40	38	44	50	40	14	36	13	90	81	320	27	710
72862-R	VDS.200+IR A-24	200	24	53	40	38	44	50	40	14	36	13	90	81	320	27	670
72921-R	VDS.250+IR A-20	250	20	60	40	38	50	57	48	17	36	19	90	104	500	30	997
72971-R	VDS.300+IR A-20	300	20	66	40	36.5	68.5	72	66	20	44	20	90	124	500	30	1375

VDS+IR-SST



Code	Description	D	dH7	L	d1	d2	d3	d4	d5	l	h	h1	H	R	C# [Nm]	L# [J]	
72685-R	VDS.100+IR-SST-10	102	10	34	22	20	27	30	25	10	22	9	45	39	60	14	171
72715-R	VDS.125+IR-SST-12	125	12	42	26	24	31	35	28	11	27	11	60	49	125	14	310
72765-R	VDS.150+IR-SST-14	150	14	44	26	24	34	38	30	12	30	10	65	56.5	180	15	436
72865-R	VDS.200+IR-SST-20	200	20	53	40	38	44	50	40	14	36	13	90	81	320	27	717

VDS+IRS

Code	Description	D	dH7	L	d1	d2	d3	d4	d5	l	h	h1	H	R	C# [Nm]	L# [J]	
72770-R	VDS.150+IRS A-8	150	8	44	26	24	34	38	30	12	30	10	65	56.5	180	15	455
72771-R	VDS.150+IRS A-14	150	14	44	26	24	34	38	30	12	30	10	65	56.5	180	15	445
72772-R	VDS.150+IRS A-16	150	16	44	26	24	34	38	30	12	30	10	65	56.5	180	15	435
72820-R	VDS.175+IRS A-8	176	8	49	35	33	39	44	35	13	28	16	80	70	195	20	590
72821-R	VDS.175+IRS A-16	176	16	49	35	33	39	44	35	13	28	16	80	70	195	20	580
72822-R	VDS.175+IRS A-20	176	20	49	35	33	39	44	35	13	28	16	80	70	195	20	570
72870-R	VDS.200+IRS A-8	200	8	53	40	38	44	50	40	14	36	13	90	81	320	27	770
72871-R	VDS.200+IRS A-20	200	20	53	40	38	44	50	40	14	36	13	90	81	320	27	730
72872-R	VDS.200+IRS A-24	200	24	53	40	38	44	50	40	14	36	13	90	81	320	27	690
72931-R	VDS.250+IRS A-20	250	20	60	40	38	50	57	48	17	36	19	90	104	500	30	955
72981-R	VDS.300+IRS A-20	300	20	66	40	36.5	68.5	72	66	20	44	20	90	124	500	30	1285

VDS+IRS-SST



Code	Description	D	dH7	L	d1	d2	d3	d4	d5	l	h	h1	H	R	C# [Nm]	L# [J]	
72775-R	VDS.150+IRS-SST-14	150	14	44	26	24	34	38	30	12	30	10	65	56.5	180	15	450
72875-R	VDS.200+IRS-SST-20	200	20	53	40	38	44	50	40	14	36	13	90	81	320	27	737



1	
2	
3	
4	
5	
6	
7	
8	
9	
10	
11	
12	
13	
14	
15	
RH	

VDN.FP | Solid handwheels, Duroplast, page 110

VDT. | Solid handwheels, technopolymer, page 114