

- 1
- 2
- 3
- 4
- 5
- 6
- 7
- 8
- 9
- 10
- 11
- 12
- 13
- 14
- 15
- RH

MATERIAL

- Cover: steel sheet, with chrome plating superficial treatment.
- Flange: zinc-plated steel sheet.
- Bayonet and flange with bayonet: zinc-plated steel sheet.

PACKING RINGS

- SMN.46: two flat packing rings in rubber-impregnated cork and one in NBR synthetic rubber.
- SMN.80 SMW.80: three flat packing rings in rubber-impregnated cork.

OVERPRESSURE VALVE (ONLY FOR SMW-BA)

- Technopolymer with NBR synthetic rubber O-ring and stainless steel spring.
- Set at around 0.350 bar (0.700 bar on request).

SUCTION VALVE (ONLY FOR SMW-BA)

- Technopolymer sealing disk with NBR synthetic rubber O-ring and stainless steel spring.
- Set at around 0.030 bar.

RING-SHAPED AIR FILTER

- Tech-foam 40 µ.

FILTER SETTING SPRING (ONLY FOR SMW.BA)

- Zinc-plated steel.

FILTRATION BASKET

- Electro zinc-plated steel, degree of filtration 800 µ.

SAFETY CHAIN (ONLY FOR SMN.80-BA/SMW.80-BA)

- Brass

STANDARD EXECUTIONS

- **SMN-BA:** breather cap.
- **SMW-BA:** double-valve breather cap.

MOUNTING

- SMN.46: by means of three glossy zinc-plated steel screws with screwdriver slot head M5x12, supplied.
- SMN.80 SMW.80: by means of six glossy zinc-plated steel screws with screwdriver slot head M5x12, supplied.

MAXIMUM CONTINUOUS WORKING TEMPERATURE

- 100°C.

SPECIAL EXECUTIONS ON REQUEST

- With dipstick for fluid level indication (only for SMW-BA).



Drilling templates

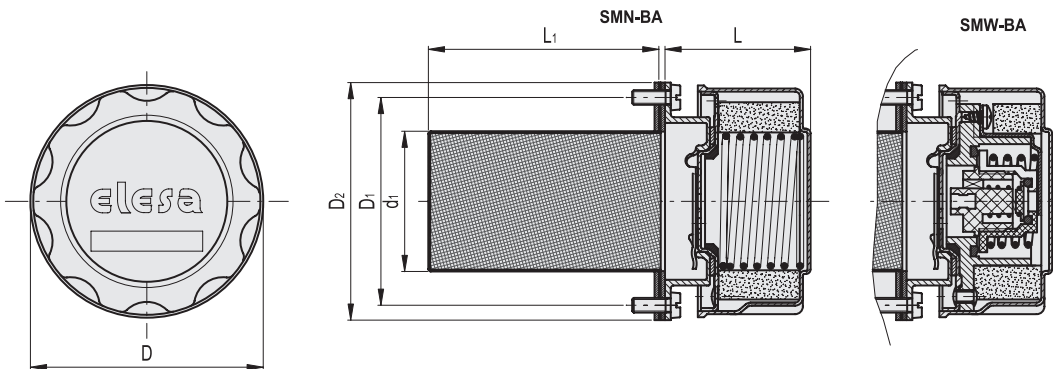
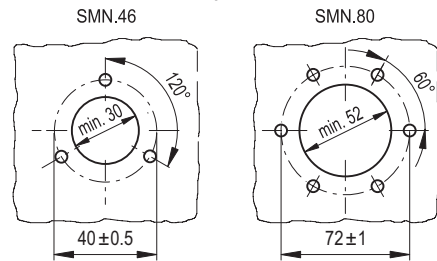

SMN-BA

| Code | Description | D | D1 | D2 | L | L1 | d1 | △ |
|--------|---------------|----|----|----|----|----|----|-----|
| 156836 | SMN.46-BA-F40 | 47 | 40 | 52 | 42 | 66 | 27 | 91 |
| 156886 | SMN.80-BA-F40 | 81 | 72 | 83 | 55 | 80 | 49 | 370 |

SMW-BA

| Code | Description | D | D1 | D2 | L | L1 | d1 | △ |
|--------|---------------------|----|----|----|----|----|----|-----|
| 156986 | SMW.80-BA-F40-350mb | 81 | 72 | 83 | 55 | 80 | 49 | 410 |

FEATURES AND APPLICATIONS

Double-valve breather caps SMW.BA with bayonet assembly creates a pressure plenum chamber right above the oil level within given limit conditions in order to avoid any reservoir deformation.

Advantages:

- it reduces reservoir air volume intake keeping clean fluid and filter;
- it improves suction pump action under working conditions reducing cavitation phenomenon;
- it prevents fluid leakage when the system is part of a mobile unit;
- it reduces foam in fluid.

TECHNICAL DATA

Air flow rate for the different executions of breather caps can be obtained from the diagram on the basis of the difference of air pressure inside and outside the reservoir. Tests carried out without filtration basket.

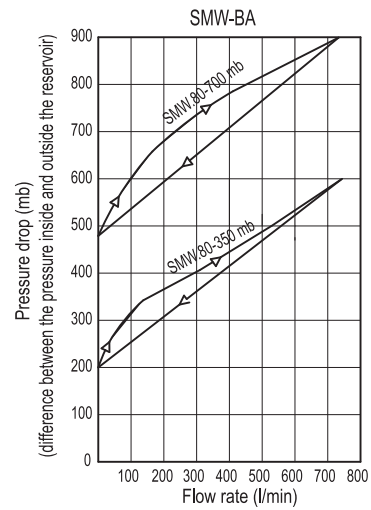
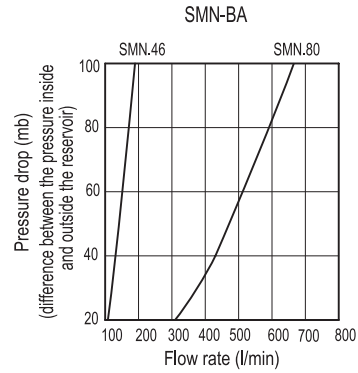

SMW-BA pressurised breather cap functioning in a hydraulic circuit

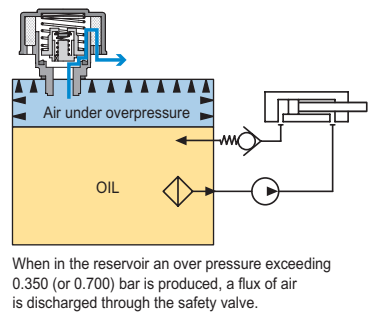
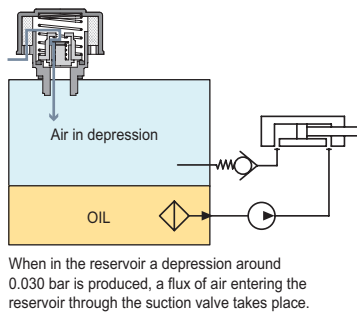
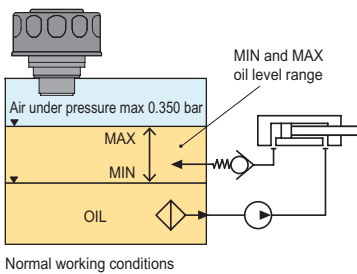

Accessories for hydraulics