

GN 274.1

Swivel clamp linear actuator connectors

•Material

Aluminium.

•Slide bush

Polyamide.

•Finish

RAL 9005 black colour **SW**, matte finish, epoxy resin coating.

•Clamping screw

- Identification no. **1**: with clamping screw DIN 912 and nut DIN 985, zinc-plated.

- Identification no. **2**: with AISI 304 stainless steel-clamping screw DIN 912 and nut DIN 985.

•Assembly

The standard clamping bolts are socket cap screws DIN 912, supplied assembled. They can be replaced by clamping kits GN 911 (description see table of dimensions).

Features and applications

Swivel clamp linear actuator connectors GN 274.1 are normally supplied only in connection with a **mounted** linear actuator and for function control.

By means of the clamping screw on the guide bore d_1 (mechanically machined) the movement can either be set or the linear actuator connector can be clamped (after setting of final adjustment).

Accessories

- Construction tubings GN 990 (see page 109ff.).

- Linear actuators GN 291 to GN 293 (see page 119ff.).

- Clamping kits GN 911 (clamping handles GN 300.1 with distance bushing see page 116).



144

Tube clamp connectors, Linear actuators

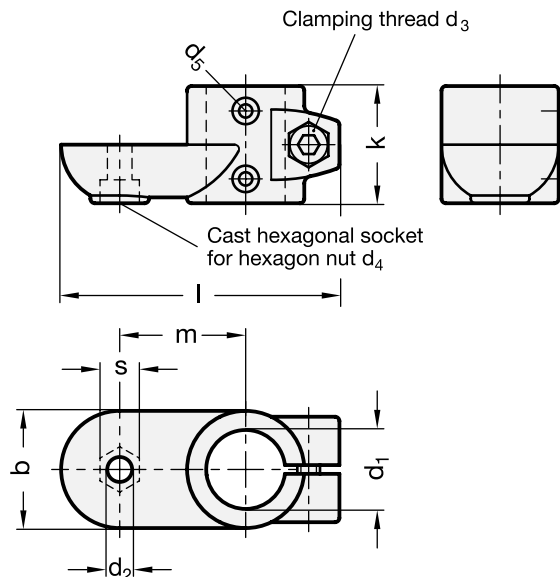

Adjustable clamping lever GN 911

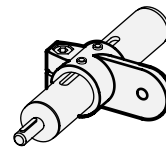

Type **OZ**
without centring step



Type **MZ**
with centring step

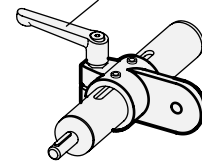

Type **AV**
with male serration

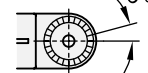
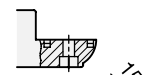
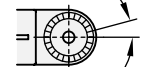
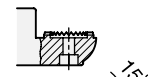

Type **IV**
with female serration

Standard Elements	Main dimensions											Clamping kits	
Description	d1 without slider bush	d1 with slider bush	b Swivel width	d2	d3	d4	d5 Mounting screw on the follower	k Clamping length	l	m	s	for d3	g
GN 274.1-B30-OZ-1-SW	B30	-	40	8.5	M8	M8	M4	40	95	43	13	GN 911-M8-32	145
GN 274.1-G30-OZ-1-SW	-	G30	40	8.5	M8	M8	M4	40	95	43	13	GN 911-M8-32	130
GN 274.1-B40-OZ-1-SW	B40	-	65	10.5	M10	M10	M5	65	148	70	17	GN 911-M10-55	700
GN 274.1-G40-OZ-1-SW	-	G40	65	10.5	M10	M10	M5	65	148	70	17	GN 911-M10-55	670
GN 274.1-B50-OZ-1-SW	B50	-	65	10.5	M10	M10	M6	65	148	70	17	GN 911-M10-55	630
GN 274.1-G50-OZ-1-SW	-	G50	65	10.5	M10	M10	M6	65	148	70	17	GN 911-M10-55	580
GN 274.1-B30-MZ-1-SW	B30	-	40	8.5	M8	M8	M4	40	95	43	13	GN 911-M8-32	145
GN 274.1-G30-MZ-1-SW	-	G30	40	8.5	M8	M8	M4	40	95	43	13	GN 911-M8-32	130
GN 274.1-B40-MZ-1-SW	B40	-	65	10.5	M10	M10	M5	65	148	70	17	GN 911-M10-55	700
GN 274.1-G40-MZ-1-SW	-	G40	65	10.5	M10	M10	M5	65	148	43	17	GN 911-M10-55	670
GN 274.1-B50-MZ-1-SW	B50	-	65	10.5	M10	M10	M6	65	148	70	17	GN 911-M10-55	630
GN 274.1-G50-MZ-1-SW	-	G50	65	10.5	M10	M10	M6	65	148	70	17	GN 911-M10-55	580
GN 274.1-B30-AV-1-SW	B30	-	40	8.5	M8	M8	M4	40	95	43	13	GN 911-M8-32	145
GN 274.1-G30-AV-1-SW	-	G30	40	8.5	M8	M8	M4	40	95	43	13	GN 911-M8-32	130
GN 274.1-B40-AV-1-SW	B40	-	65	10.5	M10	M10	M5	65	148	70	17	GN 911-M10-55	700
GN 274.1-G40-AV-1-SW	-	G40	65	10.5	M10	M10	M5	65	148	70	17	GN 911-M10-55	670
GN 274.1-B50-AV-1-SW	B50	-	65	10.5	M10	M10	M6	65	148	70	17	GN 911-M10-55	630
GN 274.1-G50-AV-1-SW	-	G50	65	10.5	M10	M10	M6	65	148	70	17	GN 911-M10-55	580
GN 274.1-B30-IV-1-SW	B30	-	40	8.5	M8	M8	M4	40	95	43	13	GN 911-M8-32	145
GN 274.1-G30-IV-1-SW	-	G30	40	8.5	M8	M8	M4	40	95	43	13	GN 911-M8-32	130
GN 274.1-B40-IV-1-SW	B40	-	65	10.5	M10	M10	M5	65	148	70	17	GN 911-M10-55	700
GN 274.1-G40-IV-1-SW	-	G40	65	10.5	M10	M10	M5	65	148	70	17	GN 911-M10-55	670
GN 274.1-B50-IV-1-SW	B50	-	65	10.5	M10	M10	M6	65	148	70	17	GN 911-M10-55	630
GN 274.1-G50-IV-1-SW	-	G50	65	10.5	M10	M10	M6	65	148	70	17	GN 911-M10-55	580
GN 274.1-B30-OZ-2-SW	B30	-	40	8.5	M8	M8	M4	40	95	43	13	GN 911-M8-32	145
GN 274.1-G30-OZ-2-SW	-	G30	40	8.5	M8	M8	M4	40	95	43	13	GN 911-M8-32	130
GN 274.1-B40-OZ-2-SW	B40	-	65	10.5	M10	M10	M5	65	148	70	17	GN 911-M10-55	700
GN 274.1-G40-OZ-2-SW	-	G40	65	10.5	M10	M10	M5	65	148	70	17	GN 911-M10-55	670
GN 274.1-B50-OZ-2-SW	B50	-	65	10.5	M10	M10	M6	65	148	70	17	GN 911-M10-55	630
GN 274.1-G50-OZ-2-SW	-	G50	65	10.5	M10	M10	M6	65	148	70	17	GN 911-M10-55	580
GN 274.1-B30-MZ-2-SW	B30	-	40	8.5	M8	M8	M4	40	95	43	13	GN 911-M8-32	145
GN 274.1-G30-MZ-2-SW	-	G30	40	8.5	M8	M8	M4	40	95	43	13	GN 911-M8-32	130
GN 274.1-B40-MZ-2-SW	B40	-	65	10.5	M10	M10	M5	65	148	70	17	GN 911-M10-55	700
GN 274.1-G40-MZ-2-SW	-	G40	65	10.5	M10	M10	M5	65	148	43	17	GN 911-M10-55	670
GN 274.1-B50-MZ-2-SW	B50	-	65	10.5	M10	M10	M6	65	148	70	17	GN 911-M10-55	630
GN 274.1-G50-MZ-2-SW	-	G50	65	10.5	M10	M10	M6	65	148	70	17	GN 911-M10-55	580
GN 274.1-B30-AV-2-SW	B30	-	40	8.5	M8	M8	M4	40	95	43	13	GN 911-M8-32	145
GN 274.1-G30-AV-2-SW	-	G30	40	8.5	M8	M8	M4	40	95	43	13	GN 911-M8-32	130
GN 274.1-B40-AV-2-SW	B40	-	65	10.5	M10	M10	M5	65	148	70	17	GN 911-M10-55	700
GN 274.1-G40-AV-2-SW	-	G40	65	10.5	M10	M10	M5	65	148	70	17	GN 911-M10-55	670
GN 274.1-B50-AV-2-SW	B50	-	65	10.5	M10	M10	M6	65	148	70	17	GN 911-M10-55	630
GN 274.1-G50-AV-2-SW	-	G50	65	10.5	M10	M10	M6	65	148	70	17	GN 911-M10-55	580
GN 274.1-B30-IV-2-SW	B30	-	40	8.5	M8	M8	M4	40	95	43	13	GN 911-M8-32	145
GN 274.1-G30-IV-2-SW	-	G30	40	8.5	M8	M8	M4	40	95	43	13	GN 911-M8-32	130
GN 274.1-B40-IV-2-SW	B40	-	65	10.5	M10	M10	M5	65	148	70	17	GN 911-M10-55	700
GN 274.1-G40-IV-2-SW	-	G40	65	10.5	M10	M10	M5	65	148	70	17	GN 911-M10-55	670
GN 274.1-B50-IV-2-SW	B50	-	65	10.5	M10	M10	M6	65	148	70	17	GN 911-M10-55	630
GN 274.1-G50-IV-2-SW	-	G50	65	10.5	M10	M10	M6	65	148	70	17	GN 911-M10-55	580