

# GN 274

## Swivel clamp connectors

### •Material

Aluminium.

### •Finish

- Version **SW**: RAL 9005 black colour, matte finish, epoxy resin coating.
- Version **BL**: blank, matte shot-blasted.

### •Types

- Type **OZ**: without centring step.
- Type **MZ**: with centring step.
- Type **AV**: with male serration.
- Type **IV**: with female serration.

### •Clamping screw

- Identification no. **1**: with clamping screw DIN 912 and nut DIN 985, zinc-plated.
- Identification no. **2**: with AISI 304 stainless steel-clamping screw DIN 912 and nut DIN 985.

### •Assembly

The standard clamping bolts are socket cap screws DIN 912, supplied assembled. They can be replaced by clamping kits GN 911 (description see table of dimensions).

### Features and applications

Swivel clamp connectors GN 274 can be assembled with swivel clamp connectors GN 272, GN 276 or GN 278 to create swivel clamp connector joints.

The clamping bore of the swivel clamp connectors GN 274 is machined and designed for construction tubings GN 990 or DIN 2391, DIN 2395 and DIN 2462 respectively.

### Accessories

- Construction tubings GN 990 (see page 109ff.).
- Clamping kits GN 911 (clamping handles GN 300.1 with distance bushing) see page 116.

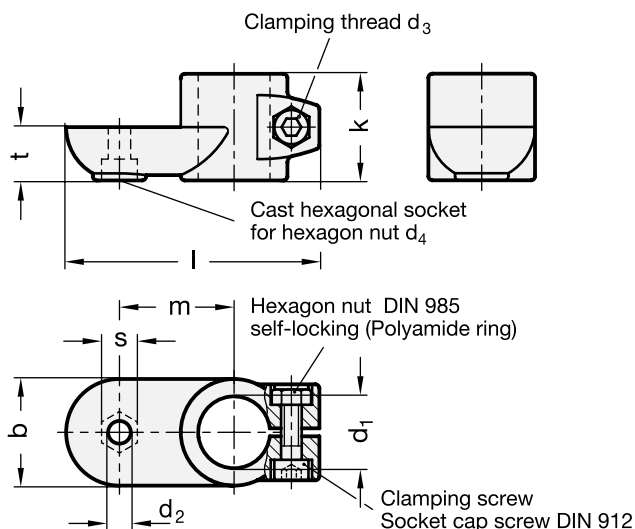

Type **OZ**  
without centring step

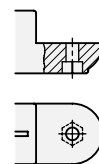

Type **AV**  
with male serration

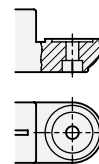
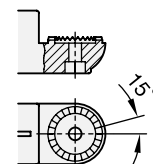

Type **MZ**  
with centring step

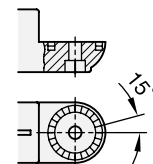

Type **IV**  
with female serration

Standard Elements	Main dimensions										Clamping kits for d3	
Description	d1	b Swivel width	d2	d3	d4	k	l	m	s	t		g
GN 274-B20-OZ-1-*	B20	40	8.5	M8	M8	40	95	43	13	20	GN 911-M8-32	190
GN 274-B25-OZ-1-*	B25	40	8.5	M8	M8	40	95	43	13	20	GN 911-M8-32	170
GN 274-B30-OZ-1-*	B30	40	8.5	M8	M8	40	95	43	13	20	GN 911-M8-32	150
GN 274-B40-OZ-1-*	B40	65	10.5	M10	M10	65	148	70	17	32.5	GN 911-M10-55	710
GN 274-B42-OZ-1-*	B42	65	10.5	M10	M10	65	148	70	17	32.5	GN 911-M10-55	685
GN 274-B45-OZ-1-*	B45	65	10.5	M10	M10	65	148	70	17	32.5	GN 911-M10-55	650
GN 274-B48-OZ-1-*	B48	65	10.5	M10	M10	65	148	70	17	32.5	GN 911-M10-55	610
GN 274-B50-OZ-1-*	B50	65	10.5	M10	M10	65	148	70	17	32.5	GN 911-M10-55	585
GN 274-B20-MZ-1-*	B20	40	8.5	M8	M8	40	95	43	13	20	GN 911-M8-32	190
GN 274-B25-MZ-1-*	B25	40	8.5	M8	M8	40	95	43	13	20	GN 911-M8-32	170
GN 274-B30-MZ-1-*	B30	40	8.5	M8	M8	40	95	43	13	20	GN 911-M8-32	150
GN 274-B40-MZ-1-*	B40	65	10.5	M10	M10	65	148	70	17	32.5	GN 911-M10-55	700
GN 274-B42-MZ-1-*	B42	65	10.5	M10	M10	65	148	70	17	32.5	GN 911-M10-55	690
GN 274-B45-MZ-1-*	B45	65	10.5	M10	M10	65	148	70	17	32.5	GN 911-M10-55	655
GN 274-B48-MZ-1-*	B48	65	10.5	M10	M10	65	148	70	17	32.5	GN 911-M10-55	615
GN 274-B50-MZ-1-*	B50	65	10.5	M10	M10	65	148	70	17	32.5	GN 911-M10-55	585
GN 274-B20-AV-1-*	B20	40	8.5	M8	M8	40	95	43	13	20	GN 911-M8-32	185
GN 274-B25-AV-1-*	B25	40	8.5	M8	M8	40	95	43	13	20	GN 911-M8-32	170
GN 274-B30-AV-1-*	B30	40	8.5	M8	M8	40	95	43	13	20	GN 911-M8-32	150
GN 274-B40-AV-1-*	B40	65	10.5	M10	M10	65	148	70	17	32.5	GN 911-M10-55	710
GN 274-B42-AV-1-*	B42	65	10.5	M10	M10	65	148	70	17	32.5	GN 911-M10-55	690
GN 274-B45-AV-1-*	B45	65	10.5	M10	M10	65	148	70	17	32.5	GN 911-M10-55	655
GN 274-B48-AV-1-*	B48	65	10.5	M10	M10	65	148	70	17	32.5	GN 911-M10-55	620
GN 274-B50-AV-1-*	B50	65	10.5	M10	M10	65	148	70	17	32.5	GN 911-M10-55	585
GN 274-B20-IV-1-*	B20	40	8.5	M8	M8	40	95	43	13	20	GN 911-M8-32	180
GN 274-B25-IV-1-*	B25	40	8.5	M8	M8	40	95	43	13	20	GN 911-M8-32	160
GN 274-B30-IV-1-*	B30	40	8.5	M8	M8	40	95	43	13	20	GN 911-M8-32	140
GN 274-B40-IV-1-*	B40	65	10.5	M10	M10	65	148	70	17	32.5	GN 911-M10-55	690
GN 274-B42-IV-1-*	B42	65	10.5	M10	M10	65	148	70	17	32.5	GN 911-M10-55	665
GN 274-B45-IV-1-*	B45	65	10.5	M10	M10	65	148	70	17	32.5	GN 911-M10-55	635
GN 274-B48-IV-1-*	B48	65	10.5	M10	M10	65	148	70	17	32.5	GN 911-M10-55	600
GN 274-B50-IV-1-*	B50	65	10.5	M10	M10	65	148	70	17	32.5	GN 911-M10-55	570

\* Complete the description of the standard item needed by adding the finish of the connector clamps: BL (blank) or SW (black).

Standard Elements	Main dimensions										Clamping kits for d <sub>3</sub>	
Description	d <sub>1</sub>	b Swivel width	d <sub>2</sub>	d <sub>3</sub>	d <sub>4</sub>	k	l	m	s	t		g
GN 274-B20-OZ-2-*	B20	40	8.5	M8	M8	40	95	43	13	20	GN 911-M8-32	190
GN 274-B25-OZ-2-*	B25	40	8.5	M8	M8	40	95	43	13	20	GN 911-M8-32	170
GN 274-B30-OZ-2-*	B30	40	8.5	M8	M8	40	95	43	13	20	GN 911-M8-32	150
GN 274-B40-OZ-2-*	B40	65	10.5	M10	M10	65	148	70	17	32.5	GN 911-M10-55	710
GN 274-B42-OZ-2-*	B42	65	10.5	M10	M10	65	148	70	17	32.5	GN 911-M10-55	685
GN 274-B45-OZ-2-*	B45	65	10.5	M10	M10	65	148	70	17	32.5	GN 911-M10-55	650
GN 274-B48-OZ-2-*	B48	65	10.5	M10	M10	65	148	70	17	32.5	GN 911-M10-55	610
GN 274-B50-OZ-2-*	B50	65	10.5	M10	M10	65	148	70	17	32.5	GN 911-M10-55	585
GN 274-B20-MZ-2-*	B20	40	8.5	M8	M8	40	95	43	13	20	GN 911-M8-32	190
GN 274-B25-MZ-2-*	B25	40	8.5	M8	M8	40	95	43	13	20	GN 911-M8-32	170
GN 274-B30-MZ-2-*	B30	40	8.5	M8	M8	40	95	43	13	20	GN 911-M8-32	150
GN 274-B40-MZ-2-*	B40	65	10.5	M10	M10	65	148	70	17	32.5	GN 911-M10-55	700
GN 274-B42-MZ-2-*	B42	65	10.5	M10	M10	65	148	70	17	32.5	GN 911-M10-55	690
GN 274-B45-MZ-2-*	B45	65	10.5	M10	M10	65	148	70	17	32.5	GN 911-M10-55	655
GN 274-B48-MZ-2-*	B48	65	10.5	M10	M10	65	148	70	17	32.5	GN 911-M10-55	615
GN 274-B50-MZ-2-*	B50	65	10.5	M10	M10	65	148	70	17	32.5	GN 911-M10-55	585
GN 274-B20-AV-2-*	B20	40	8.5	M8	M8	40	95	43	13	20	GN 911-M8-32	185
GN 274-B25-AV-2-*	B25	40	8.5	M8	M8	40	95	43	13	20	GN 911-M8-32	170
GN 274-B30-AV-2-*	B30	40	8.5	M8	M8	40	95	43	13	20	GN 911-M8-32	150
GN 274-B40-AV-2-*	B40	65	10.5	M10	M10	65	148	70	17	32.5	GN 911-M10-55	710
GN 274-B42-AV-2-*	B42	65	10.5	M10	M10	65	148	70	17	32.5	GN 911-M10-55	690
GN 274-B45-AV-2-*	B45	65	10.5	M10	M10	65	148	70	17	32.5	GN 911-M10-55	655
GN 274-B48-AV-2-*	B48	65	10.5	M10	M10	65	148	70	17	32.5	GN 911-M10-55	620
GN 274-B50-AV-2-*	B50	65	10.5	M10	M10	65	148	70	17	32.5	GN 911-M10-55	585
GN 274-B20-IV-2-*	B20	40	8.5	M8	M8	40	95	43	13	20	GN 911-M8-32	180
GN 274-B25-IV-2-*	B25	40	8.5	M8	M8	40	95	43	13	20	GN 911-M8-32	160
GN 274-B30-IV-2-*	B30	40	8.5	M8	M8	40	95	43	13	20	GN 911-M8-32	140
GN 274-B40-IV-2-*	B40	65	10.5	M10	M10	65	148	70	17	32.5	GN 911-M10-55	690
GN 274-B42-IV-2-*	B42	65	10.5	M10	M10	65	148	70	17	32.5	GN 911-M10-55	665
GN 274-B45-IV-2-*	B45	65	10.5	M10	M10	65	148	70	17	32.5	GN 911-M10-55	635
GN 274-B48-IV-2-*	B48	65	10.5	M10	M10	65	148	70	17	32.5	GN 911-M10-55	600
GN 274-B50-IV-2-*	B50	65	10.5	M10	M10	65	148	70	17	32.5	GN 911-M10-55	570

\* Complete the description of the standard item needed by adding the finish of the connector clamps: BL (blank) or SW (black).