

## Lifting eye bolts (rotating)



**• Body**

Forged AISI 318 LN stainless steel with blank surface, 100% electro-magnetic tensile tested to EN 1677.

**• Bolt**

AISI 318 LN stainless steel.

**Features**

Lifting eye bolts GN 581.5 are mounted in rotating bearings, allowing the direction of the force action to be adjusted and preventing inadvertent loosening or overturning (as potentially possible in lifting eye bolts DIN 580). Lifting eye bolts GN 581.5 offer a high load carrying capacity and they are tested to meet safety standards (safety factor 4).







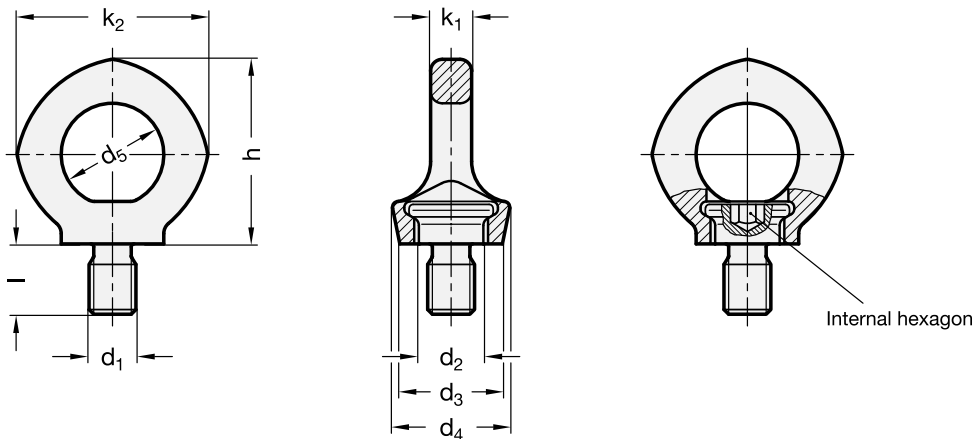



The rated load carrying capacity listed in the above table is clearly marked on the ring. It applies to the most unfavourable load application of the load types listed opposite.

Lifting eye bolts GN 581.5 eye bolts comply with Mechanical Engineering Directive 2006 / 42 / EG and are BG tested.

The hexagon socket bolt cannot be removed from the ring.

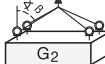

Standard Elements	Main dimensions									Nominal load	⚖ g
	d1	d2	d3	d4	d5	h	k1	k2	l		
GN 581.5-M12	M12	18	30	32	30	57	14	56	18	0.5 t [5 kN]	140
GN 581.5-M16	M16	22	35.5	38	35	66	16	65	24	1.0 t [10 kN]	333
GN 581.5-M20	M20	27.5	41.5	47	40	76	19	74	30	2.0 t [20 kN]	520
GN 581.5-M24	M24	33	50	56	48	94	24	92	35	2.5 t [25 kN]	912

Load capacity										
Method of mounting										
Number	1	1	2	2	2	2	2	3 and 4	3 and 4	3 and 4
Angles of inclination	0°	90°	0°	90°	0° to 45°	45° to 60°	asymmetrical	0° to 45°	45° to 60°	asymmetrical
Factor	1	1	2	2	1.4	1	1	2.1	1.5	1
M12	1.20 † [0.34]	0.50 †	2.40 † [0.68]	1.00 †	0.70 † [0.24]	0.50 †	0.50 †	1.06 †	0.75 †	0.50 †
M16	2.40 † [0.70]	1.00 †	4.80 † [1.40]	2.00 †	1.42 † [0.50]	1.00 †	1.00 †	2.12 †	1.50 †	1.00 †
M20	3.60 † [1.20]	2.00 †	7.20 † [2.40]	4.00 †	2.83 † [0.86]	2.00 †	2.00 †	4.24 †	3.00 †	2.00 †
M24	5.20 † [1.80]	2.50 †	10.00 † [3.60]	5.00 †	3.53 † [1.29]	2.50 †	2.50 †	5.30 †	3.75 †	2.50 †

### Safety instructions

The loads given in brackets refer to the load capacity of the corresponding lifting eye bolt DIN 580. If such a value is not indicated the use of the lifting eye bolts DIN 580 is not permitted!

The bolton surface for the lifting eye bolts GN 581.5 must be plane and at a right angle to the threaded borehole; the countersinking must be  $\leq$  the nominal diameter of the thread.

Screwed in, the collar of the screw must make firm contact (do not use washers) and the eye bolt must rotate freely by 360°.

Before applying the load, turn the lifting eye bolt in the direction of the force. The lifting eye bolt is not suitable for frequent rotation cycles under load.

The specified load values apply for a minimum screw-in length of  $1,5 \times$  nominal thread diameter in steel with a minimum tensile strength of 37 kp/mm<sup>2</sup>, at an ambient temperature of - 40 °C to + 280 °C. Load-bearing capacity under different conditions upon request.

Operating instructions with more details and specifications are included with every delivery.