

GN 581

EXTENDED RANGE

Lifting eye bolts (rotating)

RoHS

• Body

High-tensile forged tempered steel with pink plastic surface coating with 100% electro-magnetic tensile test to EN 1677.

- Type **B**: with spanner.

- Type **A**: without spanner.

• Bolt

Steel, class 10.9 (tensile strength 1000 N/mm²), 100% electro-magnetic tensile test to EN 1677.

Features

The lifting eye bolts GN 581 are mounted in rotating bearings, allowing the direction of the force action to be adjusted and preventing inadvertent loosening or overturning (as potentially possible in lifting eye bolts DIN 580).

Lifting eye bolts GN 581 offer a high load carrying capacity and they are tested to meet safety standards (safety factor 4).

The rated load carrying capacity listed in the above table is clearly marked on the ring. It applies to the most unfavourable load application of the load types listed opposite.







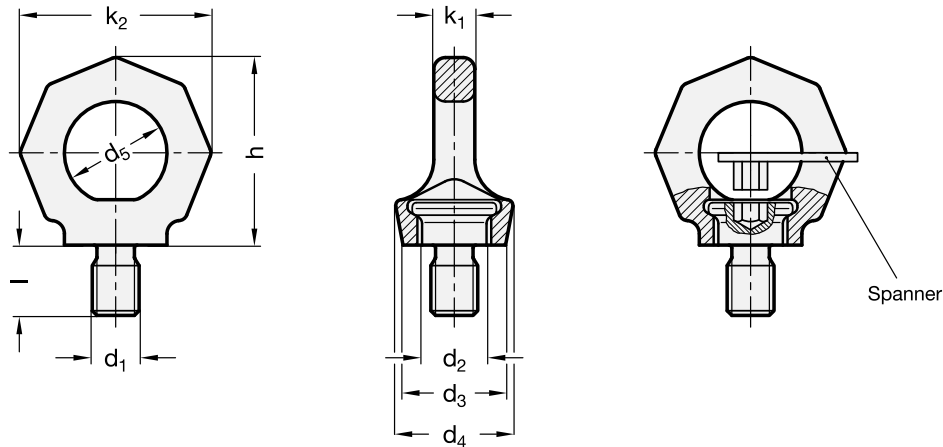



Lifting eye bolts GN 581 comply with Mechanical Engineering Directive 2006 / 42 / EG and are BG tested.

The hexagon socket bolt cannot be removed from the ring.

Type B is suitable for assembly without the need to use tools: inserting the spanner in the hexagon socket of the bolt allows the bolt to be turned in and out by hand.



Standard Elements	Main dimensions									Nominal load	Δ _g
	Description	d ₁	d ₂	d ₃	d ₄	d ₅	h	k ₁	k ₂		
GN 581-M8-A	M8	16	25	32	25	45	8.5	47	12	0.3 t (3 kN)	100
GN 581-M10-A	M10	16	25	32	25	45	8.5	47	15	0.4 t (4 kN)	120
GN 581-M12-A	M12	20	30	34	30	55	10	56	18	0.75 t (7.5 kN)	180
GN 581-M16-A	M16	23.5	35	40	35	64	14	65	24	1.5 t (15 kN)	320
GN 581-M20-A	M20	29	42	50	40	74	16	75	30	2.3 t (23 kN)	490
GN 581-M24-A	M24	35	50	60	48	90	19	90	36	3.2 t (32 kN)	900
GN 581-M30-A	M30	44	60	75	60	112	24	112	45	4.5 t (45 kN)	1650
GN 581-M36-A	M36	53	75	90	72	135	29	135	54	7.0 t (70 kN)	3100
GN 581-M8-B	M8	16	25	32	25	45	8.5	47	12	0.3 t (3 kN)	115
GN 581-M10-B	M10	16	25	32	25	45	8.5	47	15	0.4 t (4 kN)	130
GN 581-M12-B	M12	20	30	34	30	55	10	56	18	0.75 t (7.5 kN)	190
GN 581-M16-B	M16	23.5	35	40	35	64	14	65	24	1.5 t (15 kN)	340
GN 581-M20-B	M20	29	42	50	40	74	16	75	30	2.3 t (23 kN)	555
GN 581-M24-B	M24	35	50	60	48	90	19	90	36	3.2 t (32 kN)	950
GN 581-M30-B	M30	44	60	75	60	112	24	112	45	4.5 t (45 kN)	1860
GN 581-M36-B	M36	53	75	90	72	135	29	135	54	7.0 t (70 kN)	3040

Load capacity										
Method of mounting										
Number	1	1	2	2	2	2	2	3 and 4	3 and 4	3 and 4
Angles of inclination	0°	90°	0°	90°	0° to 45°	45° to 60°	asymmetrical	0° to 45°	45° to 60°	asymmetrical
Factor	1	1	2	2	1.4	1	1	2.1	1.5	1
M8	1.00 t [0.14]	0.30 t	2.00 [0.28]	0.60 t	0.42 [0.10]	0.30 t	0.30 t	0.63 t	0.45 t	0.30 t
M10	1.00 t [0.23]	0.40 t	2.00 [0.46]	0.80 t	0.56 [0.17]	0.40 t	0.40 t	0.84 t	0.60 t	0.40 t
M12	2.00 t [0.34]	0.75 t	4.00 t [0.68]	1.50 t	1.00 [0.24]	0.75 t	0.75 t	1.60 t	1.12 t	0.75 t
M16	4.00 t [0.70]	1.50 t	8.00 t [1.40]	3.00 t	2.10 [0.50]	1.50 t	1.50 t	3.15 t	2.25 t	1.50 t
M20	6.00 t [1.20]	2.00 t	12.00 t [2.40]	4.60 t	3.22 [0.86]	2.30 t	2.30 t	4.83 t	3.45 t	2.30 t
M24	8.00 t [1.80]	3.20 t	16.00 t [3.60]	6.40 t	4.48 [1.29]	3.20 t	3.20 t	6.70 t	4.80 t	3.20 t
M30	12.00 t [3.20]	4.50 t	24.00 [6.40]	9.00 t	6.30 [2.30]	4.50 t	4.50 t	9.40 t	6.70 t	4.50 t
M36	16.00 t [4.60]	7.00 t	32.00 [9.20]	14.00 t	9.80 [3.30]	7.00 t	7.00 t	14.70 t	10.50 t	7.00 t

Safety instructions

The loads given in brackets refer to the load capacity of the corresponding lifting eye bolt DIN 580. If such a value is not indicated the use of the lifting eye bolts DIN 580 is not permitted!

The bolt-on surface for the lifting eye bolts GN 581 must be plane and at a right angle to the threaded borehole; the countersinking must be \leq the nominal diameter of the thread.

Screwed in, the collar of the screw must make firm contact (do not use washers) and the eye bolt must rotate freely by 360°.

Before applying the load, turn the lifting eye bolt in the direction of the force. The lifting eye bolt is not suitable for frequent rotation cycles under load.

The specified load values apply for a minimum screw-in length of $1,5 \times$ nominal thread diameter in steel with a minimum tensile strength of 37 kp/mm², at an ambient temperature of -40 °C to +100 °C. Load-bearing capacity under different conditions upon request.

Operating instructions with more details and specifications are included with every delivery.