

Latches with handle

PA

- **Handle and base**

Glass-fibre reinforced polyamide based (PA) technopolymer. Resistant to solvents, oils, greases and other chemical agents.

- **Colour**

Black, matte finish.

- **Handle shank**

Zinc alloy with superficial chromate treatment and NBR synthetic rubber O-ring.

- **Sealing washer**

Silicon directly applied under the handle base and NBR synthetic rubber O-ring (only for execution IP 65).

- **Screws**

Zinc-plated steel.

- **Standard executions available**

- CLT.: lock with different combinations. Each lock has two nickel-plated brass keys, with different combination, removable at 180°.

- CLTEU.: lock with different combinations with European stator. Each lock has two nickel-plated brass keys, with different combination, removable at 180°.

- CLTU.: lock with one combination. All locks have two nickel-plated brass keys, with the same combination, removable at 180°.

- CLTU-EU.: lock with one combination with European stator. All locks have two nickel-plated brass keys, with the same combination, removable at 180°.

- CLTA.: lock for technopolymer key with zamac insert, with two-wings key mark, included in the supply.

- CLTA-EU.: lock with European stator, for technopolymer key with zamac insert, with two-wings key mark, included in the supply.

- **IP protection**

Execution with suffix **-IP**: protection plug and sealing washer with IP 65 protection class, according to IEC 529 table (see page 503), with two zinc-plated set screws included in the supply.



13

878

Latches

Accessories on request

Other accessories available on request are:

- one pair of black technopolymer rod guides: one rod guide every 500 mm of rod length (code 421133 description C.GAT);

- one pair of flat galvanised steel rods, cross section 14x3 mm, length 1,000 mm and edge rollers in black technopolymer, for frame thickness of 20 mm (code 421135 description C.AT 1000-20) or 25 mm (code 421136 description C.AT 1000-25);

- latches with lock with different mark.

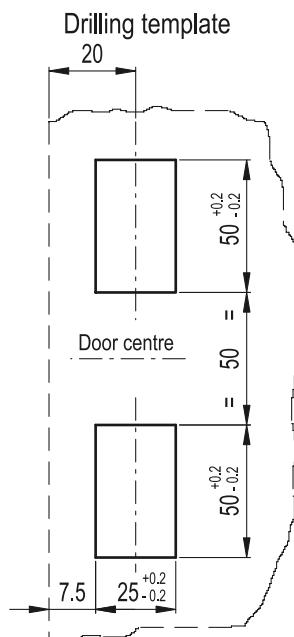

CLT-EU
CLTA-EU
CLTU-EU

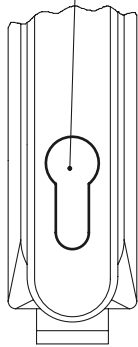

CLTA.

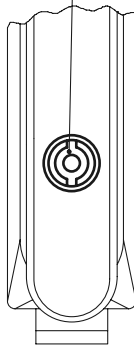

CLT. CLTU.

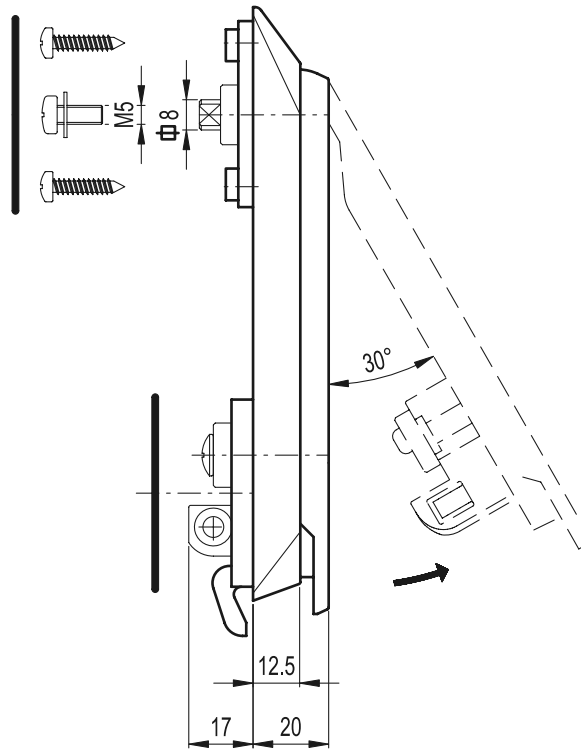
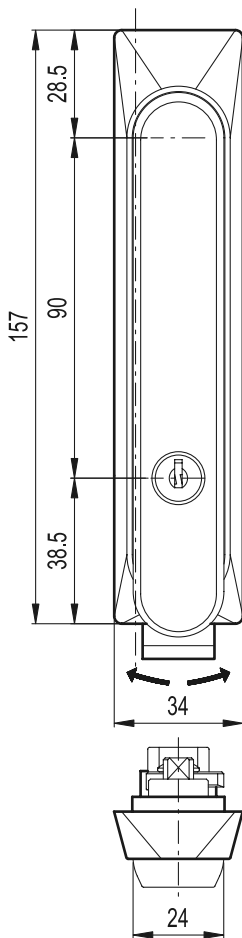
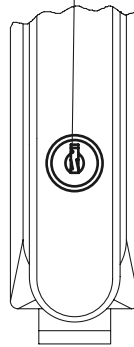

CLT-IP
CLTA-IP
CLTU-IP

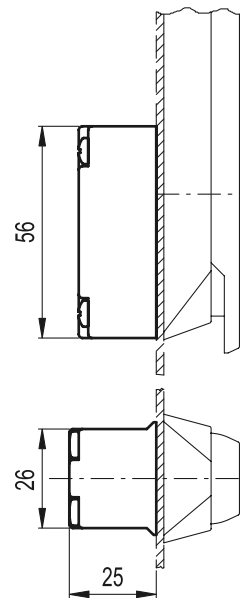

Standard Elements		⚖
Code	Description	g
421161	CLT.160	145
421162	CLT.160-IP	160
421163	CLT.160-EU	155
421164	CLT.160-EU-IP	170
421166	CLTU.160	145
421167	CLTU.160-IP	160
421168	CLTU.160-EU	155
421169	CLTU.160-EU-IP	170
421171	CLTA.160	150
421173	CLTA.160-IP	165
421175	CLTA.160-EU	160
421177	CLTA.160-EU-IP	175